

6506EL1

650 V E-mode GaN Transistor

Features

- 650 V enhancement mode GaN power transistor
- Advanced GaN-on-QST technology
- TOLL package
- Typical $R_{DS(on)} = 60\text{ m}\Omega$
- $I_{DS\ max,DC} = 20\text{ A}$
- Simple gate drive 0 V to 6 V and large $V_{GS(th)}$
- High switching frequency (> 1 MHz)
- Reverse conduction capability
- Zero reverse recovery loss
- Kelvin Source for optimized gate drive

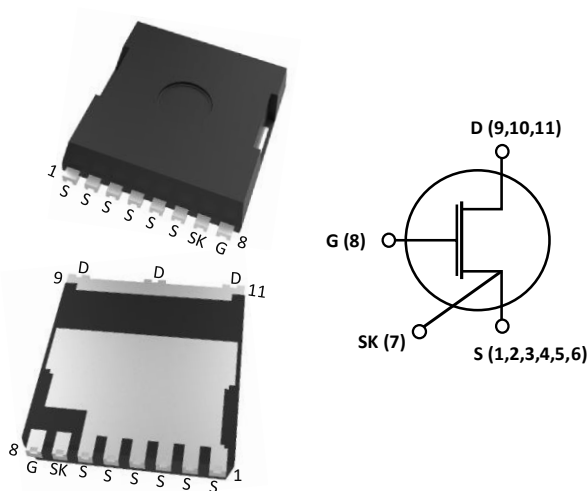

Applications

- DC-DC converters
- AC-DC converters
- Fast Battery Charging
- Industrial Motor Drives
- Power Factor Correctors
- Industrial Power Supplies

Description

The 6506EL1 is an enhancement mode GaN transistor designed for large power density and high switching frequency. Its large threshold voltage and the presence of a kelvin source connection enable fast and safe gate driving. These features enable high efficiency and reliable power switching.

Pin Description

Pin No.	Pin Name	Description
9,10,11	D	Drain
1,2,3,4,5,6	S	Source
7	SK	Kelvin Source
8	G	Gate

Absolute Maximum Ratings

$T_J = 25\text{ }^\circ\text{C}$ except as noted. Exceeding the maximum ratings may damage the device.

Parameter	Symbol	Value	Unit
Drain-to-Source Voltage	V_{DS}	650	V
Drain-to-Source Voltage – transient (Note 1)	V_{DS} (transient)	750	V
Gate-to-Source Voltage	V_{GS}	-10 to +7	V
Gate-to-Source Voltage – transient (Note 1)	V_{GS} (transient)	-20 to 10	V
Continuous Drain Current ($T_{case} = 25\text{ }^\circ\text{C}$)	I_{DS}	20	A
Pulsed Drain Current ($T_{case} = 25\text{ }^\circ\text{C}$) (Pulse width 10us, $V_{GS} = 6\text{ V}$) (Note 2)	$I_{DS, Pulse}$	45	A
Pulsed Drain Current ($T_{case} = 150\text{ }^\circ\text{C}$) (Pulse width 10us, $V_{GS} = 6\text{ V}$) (Note 2)	$I_{DS, Pulse}$	20	A
Max Power Dissipation at $T_{case} = 25\text{ }^\circ\text{C}$	P_{tot}	212	W
Operating Junction Temperature	T_J	-55 to +150	$^\circ\text{C}$
Storage Temperature Range	T_S	-55 to +150	$^\circ\text{C}$

Note 1: for pulses $\leq 100\text{us}$

Note 2: Defined by product design and characterization. Value is not tested to full current in production.

Thermal Characteristics

Parameter	Symbol	Value	Unit
Thermal Resistance Junction-to-Case – (bottom side)	$R_{TH,J-C}$	0.59	$^\circ\text{C/W}$
Thermal Resistance Junction-to- Ambient (Note 3)	$R_{TH,J-A}$	34.5	$^\circ\text{C/W}$

Note 3: Based on a 4-layer, 1.6 mm-thick PCB. The copper thickness of the external layer is 2 oz. while the buried layers are 1 oz. thick. PCB in a horizontal position without air stream cooling.

Electrical Characteristics

Static Characteristics

Parameters	Symbol	Min	Typ	Max	Unit	Condition
Drain-to-Source On Resistance	$R_{DS(on)}$	-	60	90	mΩ	$I_{DS} = 8\text{ A}, V_{GS} = 6\text{ V}, T_J = 25\text{ °C}$
		-	134	-	mΩ	$I_{DS} = 8\text{ A}, V_{GS} = 6\text{ V}, T_J = 150\text{ °C}$
Gate-to-Source Threshold Voltage	$V_{GS(th)}$	1.1	1.7	2.6	V	$I_{DS} = 2.4\text{ mA}, T_J = 25\text{ °C}$
		-	1.53	-	V	$I_{DS} = 2.4\text{ mA}, T_J = 150\text{ °C}$
Gate-to-Source Current	I_{GS}	-	300	-	μA	$V_{GS} = 6\text{ V}, T_J = 25\text{ °C}$
Drain-to-Source Leakage Current	I_{DSS}	-	65	-	μA	$V_{DS} = 650\text{ V}, T_J = 25\text{ °C}$
		-	90	-	μA	$V_{DS} = 650\text{ V}, T_J = 150\text{ °C}$
Internal Gate Resistance	R_G	-	1.32	-	Ω	f = 5 MHz, open drain

Dynamic Characteristics

Input Capacitance	C_{ISS}	-	295	-	pF	$V_{DS} = 400\text{ V}, V_{GS} = 0\text{ V}, f = 100\text{ kHz}$
Output Capacitance	C_{OSS}	-	70	-	pF	
Reverse Transfer Capacitance	C_{RSS}	-	0.4	-	pF	
Effective Output Capacitance, Energy-Related (Note 4)	$C_{O(ER)}$	-	100	-	pF	$V_{DS} = 0\text{ V to }400\text{ V}, V_{GS} = 0\text{ V}$
Effective Output Capacitance, Time-Related (Note 5)	$C_{O(TR)}$	-	137	-	pF	
Output Charge	Q_{OSS}	-	55.8	-	nC	$V_{DS} = 0\text{ V to }400\text{ V}$
Turn-On Delay	$t_{D(on)}$	-	4	-	ns	$V_{DD} = 400\text{ V}, V_{GS} = 0\text{ to }6\text{ V}, I_{DS} = 16\text{ A}, R_{G(on)} = 10\text{ Ω}, R_{G(off)} = 2.2\text{ Ω}, L = 100\text{ μH (see Figure 14,15)}$
Rise Time	t_R	-	7	-	ns	
Turn-Off Delay	$t_{D(off)}$	-	4	-	ns	
Fall Time	t_F	-	7	-	ns	
Switching Energy During Turn-on	E_{on}	-	33	-	μJ	

Switching Energy During Turn-off	E_{off}	-	12	-	μJ	
Output Capacitance Stored Energy	E_{OSS}	-	8	-	μJ	$V_{DS} = 0 \text{ V to } 400 \text{ V}$

Note 4: $C_{O(ER)}$ is a fixed capacitance that would give the same stored energy as C_{OSS} while V_{DS} is rising from 0 V to the stated V_{DS} .

Note 5: $C_{O(TR)}$ is a fixed capacitance that would give the same charging time as C_{OSS} while V_{DS} is rising from 0 V to the stated V_{DS} .

Gate Charge Characteristics

Total Gate Charge	Q_G	-	9.8	-	nC	$V_{GS} = 0 \text{ to } 6 \text{ V},$ $V_{DS} = 0 \text{ to } 400 \text{ V},$ $I_{DS} = 8 \text{ A}$
Gate-to-Source Charge	Q_{GS}	-	1.1	-	nC	
Gate-to-Drain Charge	Q_{GD}	-	6.7	-	nC	
Gate Plateau Voltage	V_{Plat}	-	1.93	-	V	$V_{DS} = 400 \text{ V}, I_{DS} = 10 \text{ A}$

Reverse Conduction Characteristics

Source-Drain Reverse Voltage	V_{SD}	-	2.5	-	V	$V_{GS} = 0 \text{ V}, I_{SD} = 4 \text{ A}$
Reverse Recovery Charge	Q_{rr}	-	0	-	nC	
Reverse Recovery Time	t_{rr}	-	0	-	ns	

Electrical Performance Graphs

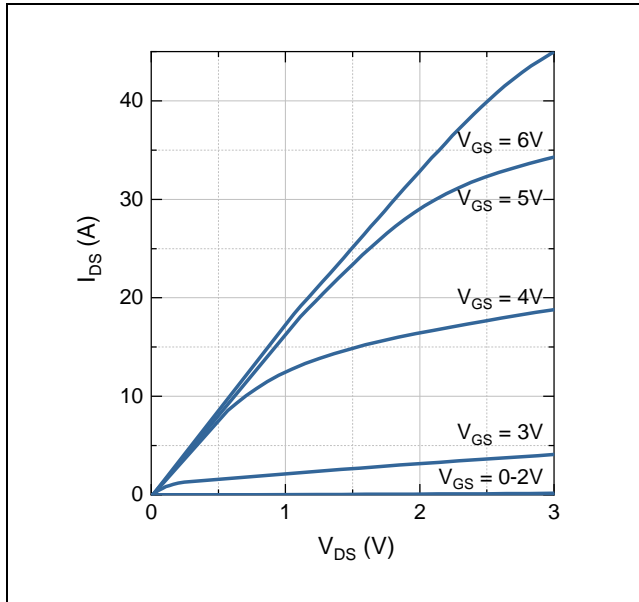

Figure 1: Typical pulsed I_{DS} vs. V_{DS} at $T_J = 25\text{ }^\circ\text{C}$

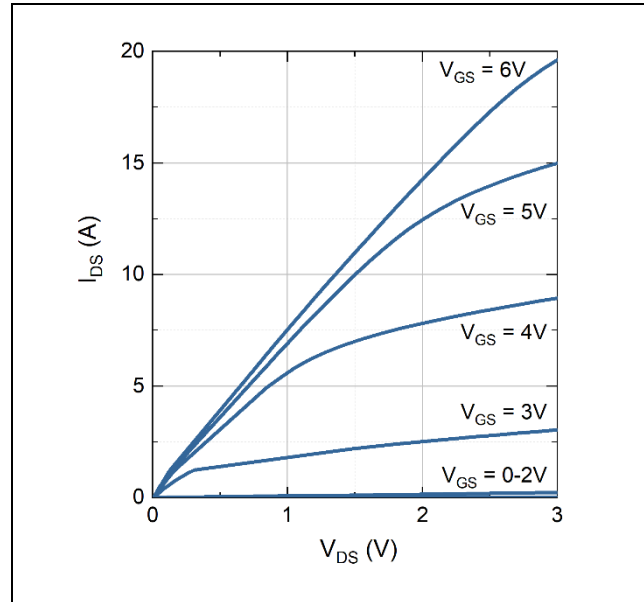

Figure 2: Typical pulsed I_{DS} vs. V_{DS} at $T_J = 150\text{ }^\circ\text{C}$

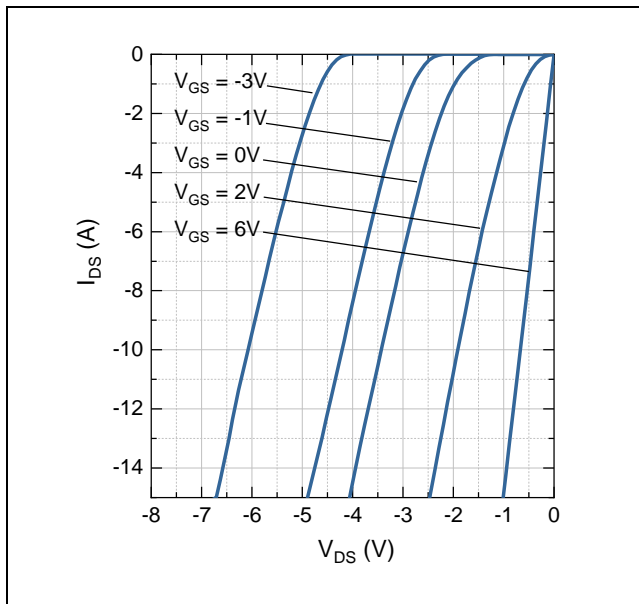

Figure 3: Typical Reverse Conduction Characteristics at $T_J = 25\text{ }^\circ\text{C}$

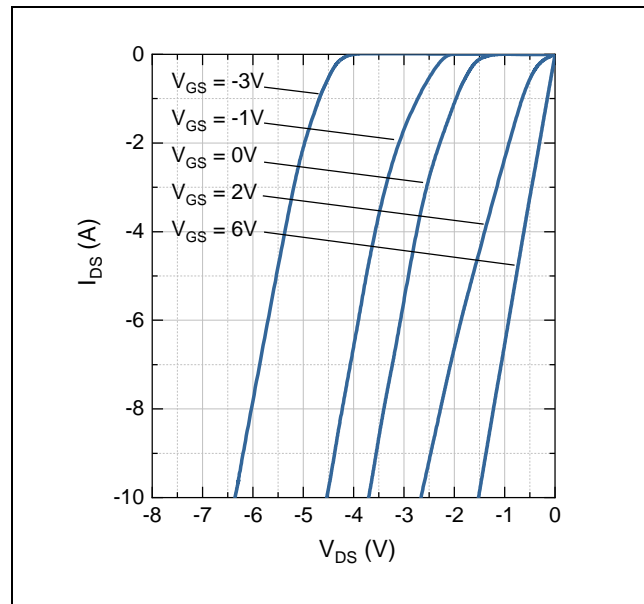

Figure 4: Typical Reverse Conduction Characteristics at $T_J = 150\text{ }^\circ\text{C}$

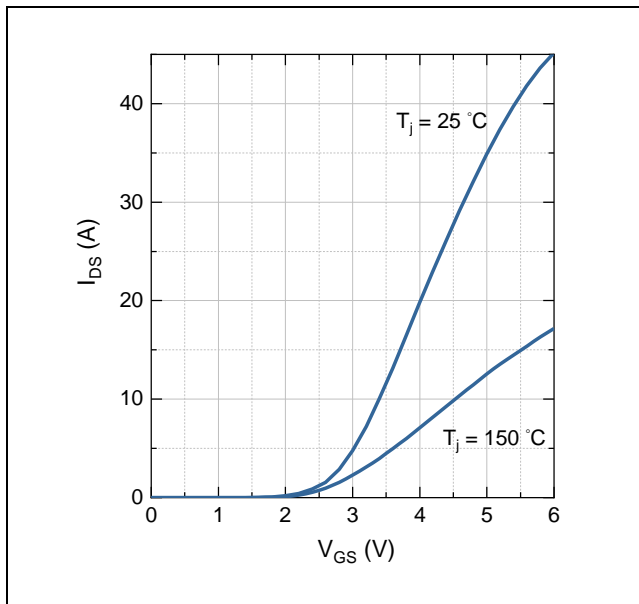

Figure 5: Typical I_{DS} vs. V_{GS} at $T_J = 25\text{ °C}$ and $T_J = 150\text{ °C}$ for $V_{DS} = 3\text{ V}$

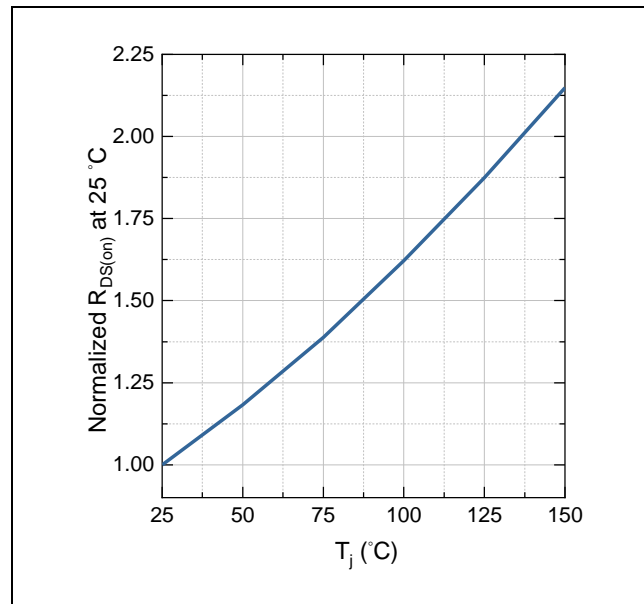

Figure 6: Normalized $R_{DS(on)}$ as a function of T_J

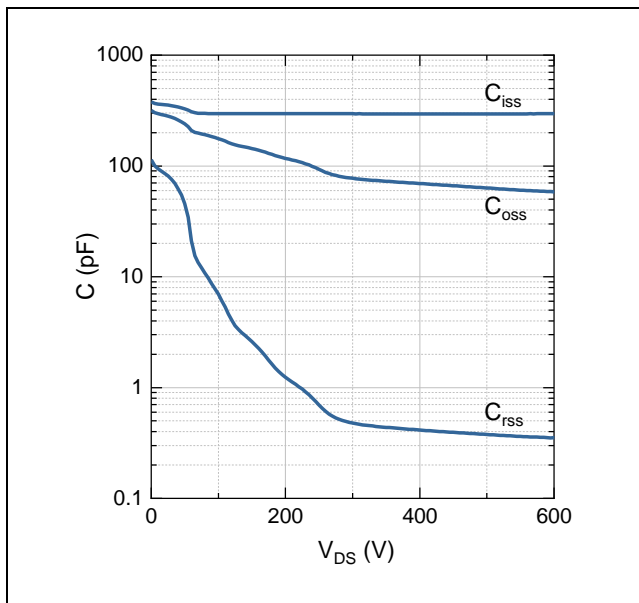

Figure 7: Typical C_{iss} , C_{oss} , C_{rss} vs. V_{DS}

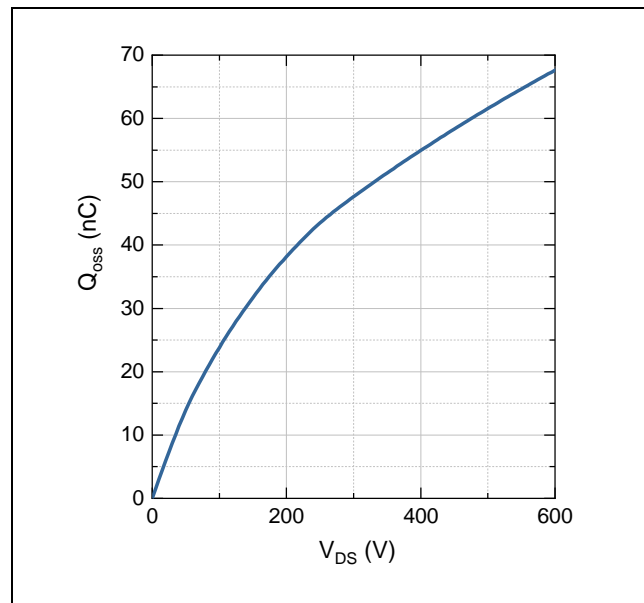

Figure 8: Typical charge stored in C_{oss}

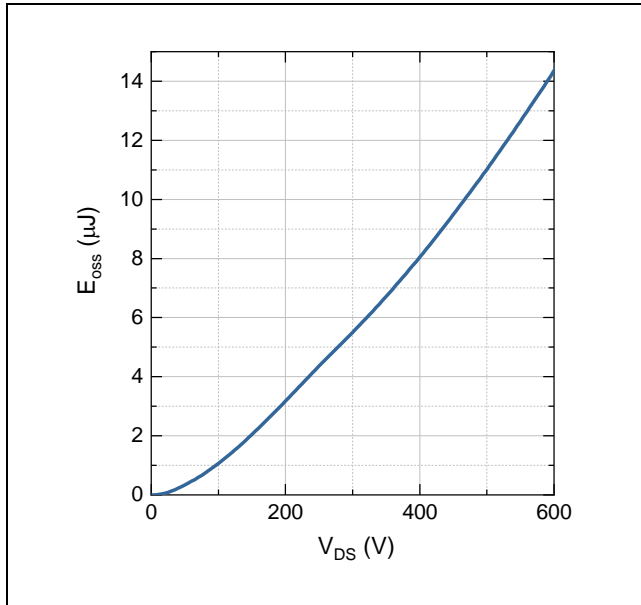

Figure 9: Typical energy stored in C_{oss}

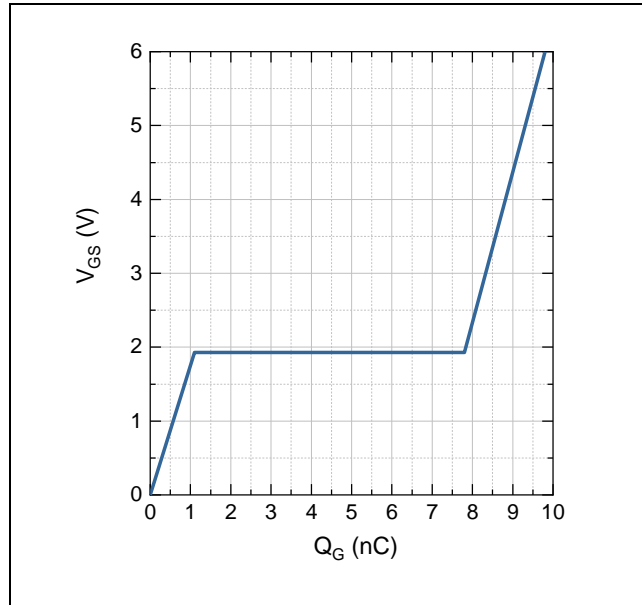

Figure 10: Typical V_{GS} vs. Q_G at V_{DS} = 400 V

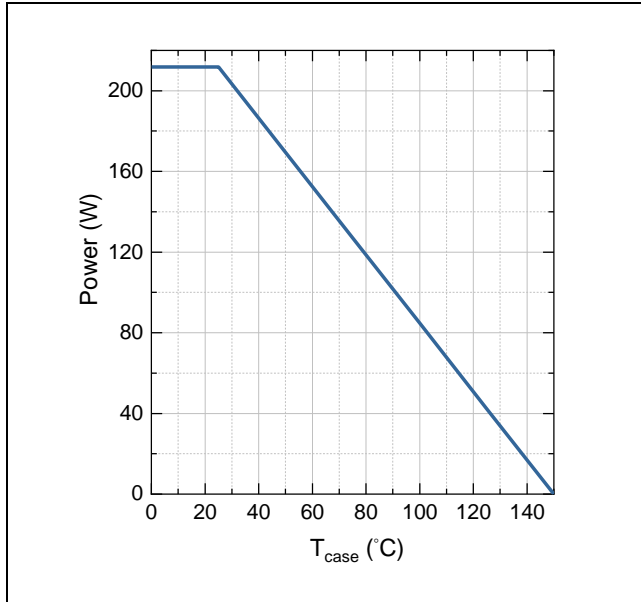

Figure 11: Power Derating vs. T_{case}

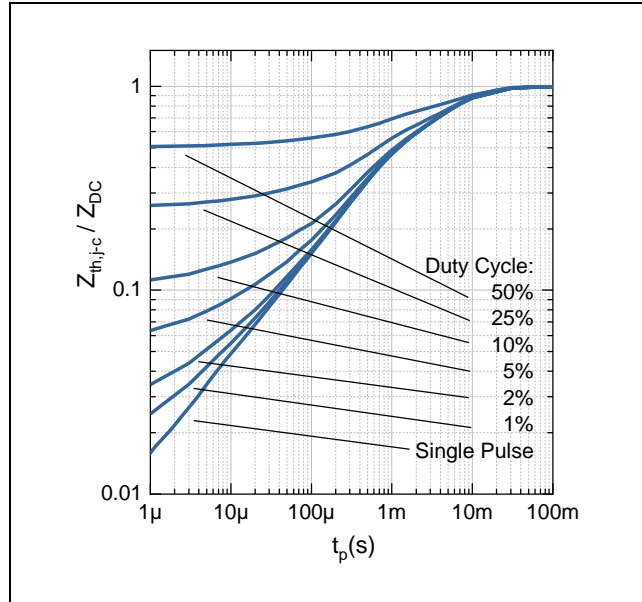

Figure 12: Normalized Transient Thermal Impedance

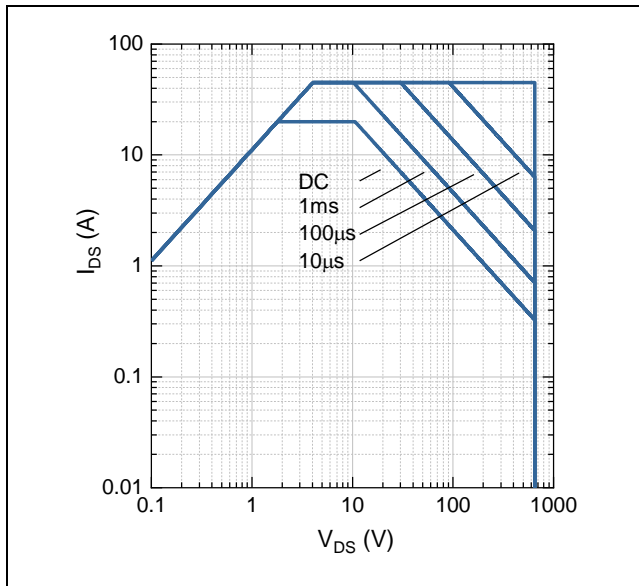

Figure 13: Safe Operating Area at $T_{case} = 25\text{ }^{\circ}\text{C}$

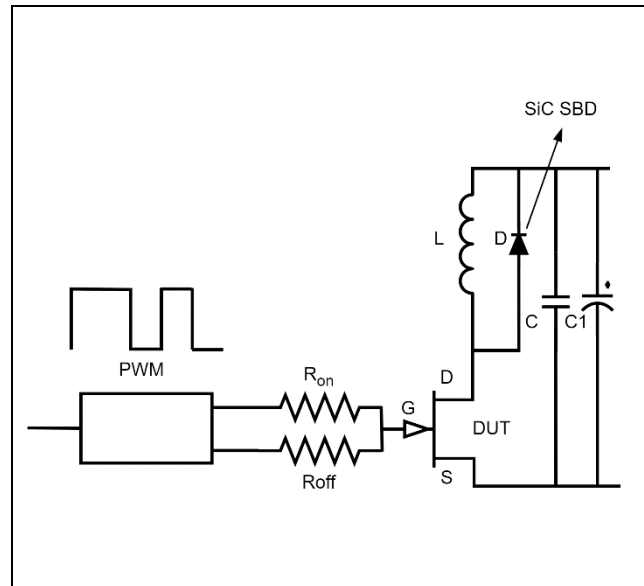

Figure 14: DPT circuit used for switching times measurement, $V_{DS} = 400\text{ V}$, $I_{DS} = 16\text{ A}$, $L = 100\text{ }\mu\text{H}$, $V_{GS} = 6\text{ V}$, $R_{on} = 10\text{ }\Omega$, $R_{off} = 2.2\text{ }\Omega$

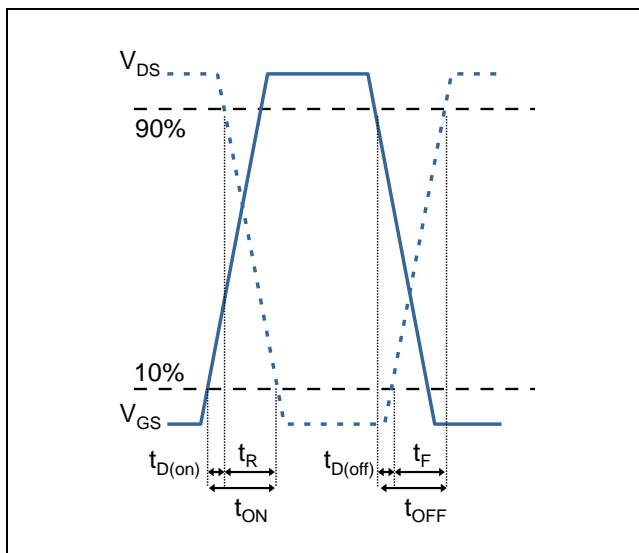
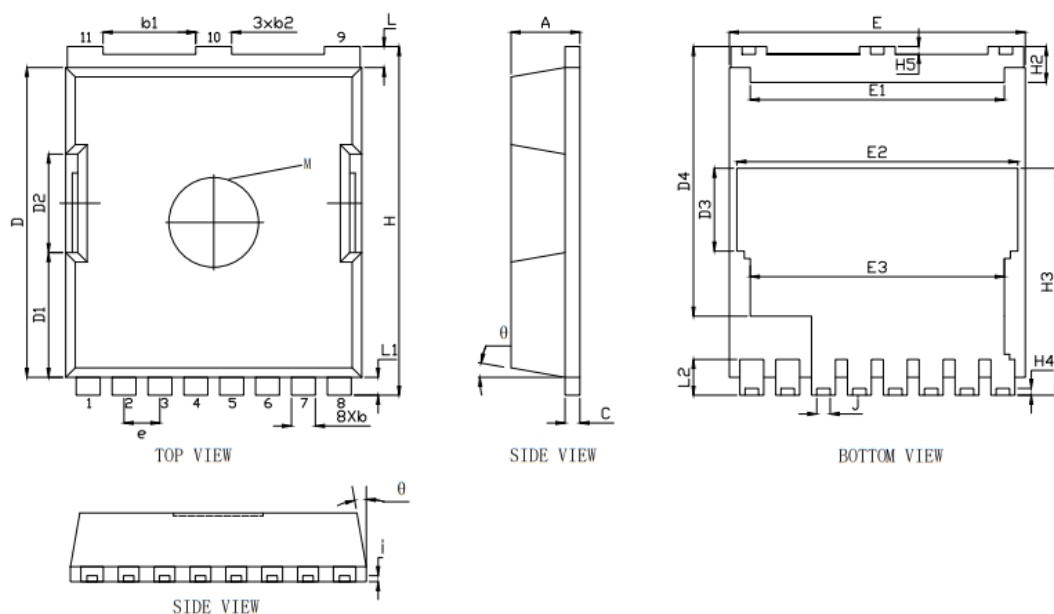

Figure 15: Switching waveform used to determine the switching times values

Package Information



SYMBLE	MILLIMETER			SYMBLE	MILLIMETER		
	MIN	NOM	MAX		MIN	NOM	MAX
A	2.20	2.30	2.40	e	1.10	1.20	1.30
b	0.70	0.80	0.90	H	11.48	11.68	11.88
b1	3.00	3.10	3.20	H2	1.00	1.20	1.40
b2	1.10	1.20	1.30	H3	7.50	7.60	7.70
c	0.40	0.50	0.60	H4	0.13	0.23	0.33
D	10.18	10.38	10.58	H5	0.26 REF		
D1	4.18 REF			i	0.10	-	-
D2	3.30 REF			j	0.42	0.45	0.50
D3	2.77 REF			L	0.50	0.70	0.90
D4	9.03 REF			L1	0.50	0.60	0.70
E	9.70	9.90	10.10	L2	1.05	1.20	1.30
E1	8.50 REF			M	3 REF		
E2	9.40 REF			θ	8°	10°	12°
E3	8.50 REF						

Notes:

- (1) Dimension and tolerance conform to ASME Y14.5-2009.
- (2) All dimensions are in millimeters.
- (3) Lead coplanarity shall be 0.1 millimeters max.
- (4) Complies with JEDEC MO-229.
- (5) Drawing is not to scale.
- (6) Dimensions do not include mold protrusion.
- (7) Package outline exclusive of metal burr dimensions.

Disclaimer

The information given in this document is intended as a reference only and shall not in any event be regarded as a guarantee of performance. Novawave does not assume any liability arising out of the use of any product described herein, including but not limited to any personal injury, death, or property or environmental damage. The products shown herein are not designed for use as critical components in medical, life-saving, or life-sustaining applications, whose failure to perform can be reasonably expected to cause the failure of the life support device or system, or to affect its safety or effectiveness. No license, patent right, or any other intellectual property right is granted or conveyed. Novawave reserves the right to make changes without further notice to any products herein to improve reliability, function, or design. Novawave standard terms and conditions apply. All rights reserved.